



TL-2424 USER`S MANUAL



TL elektronik
Airport, Building 125, Hradec Kralove
503 41, Czech Republic

© Copyright 2003-2006
TL elektronik
All Rights Reserved

Except as expressly provided below, no part of this manual may be downloaded, transmitted, copied, reproduced, disseminated or stored in any storage medium, for any purpose without the express prior written consent of the TL elektronik company. Address your questions about the technical information to TL elektronik. Other information about sale, distribution should be directed to our exclusive distributors (see World Distributor list on our website).

Producer's address:
TL elektronik Inc.
Airport, Building 125,
503 41 Hradec Kralove, Czech Republic
Fax: +420 49 548 23 94 E-mail: info@tl-elektronic.com
Website Address: www.tl-elektronic.com

***Please, send your e-mail address to customer@tl-elektronic.com
to receive the latest information about the software upgrade.***

*Send your ideas to innovation@tl-elektronic.com.
We will evaluate your suggestion and provide an update.*

Record of revision

Revision	Revision date	Description	ECO#	Insertion date	By
A	1/6/03	Initial Release	---		
B	1/7/04	Language correction	0001		
C	1/10/05	Functions correction	0002		

Window is registered trademark of Microsoft Corporation.
All trademarks and registered trademarks are acknowledged.
Scheck® is registered trademark of TL elektronik.
iFamily® is registered trademark of TL elektronik.
sModern® is registered trademark of TL elektronik.

All information in this User's manual is subject to change without prior notice.

TABLE OF CONTENTS

1. GENERAL DESCRIPTION	
1.1. Introduction.....	1-1
1.2. Instrument Description.....	1-1
1.3. Technical Specifications.....	1-2
1.4. Limited Conditions.....	1-3
1.5. Limited Warranty.....	1-3
1.6. Limited Operation.....	1-3
2. INSTALLATION	
2.1. Introduction.....	2-1
2.2. Rack Consideration.....	2-1
2.3. Installation into Panel.....	2-1
2.4. Instrument Dimensions.....	2-2
3. SYSTEM INTERCONNECT	
3.1. Pin Function List.....	3-1
3.2. TL-2424 Interconnects.....	3-2
3.2. TL-2424 Audio Interconnects.....	3-3
3.3. TL-2424 Connector Location.....	3-4
4. NAV-MENU DESCRIPTION	
4.1. How to Control Instrument via NAV-MENU.....	4-1
5. INSTRUMENT SETUP	
5.1. First Instrument Turn-on.....	4-1
5.2. Main Set-up Functions' Description.....	5-1
5.3. How to Set Side Tone Volume.....	5-2
5.4. How to Set Warning Message Volume.....	5-2
5.5. How to Enable Identification Playing Mode.....	5-2
5.6. How to Record Identification.....	5-3
5.7. How to Enable Emergency Mode.....	5-3
5.8. How to Record Emergency Message.....	5-3
5.9. How to Select Audio Source to AUX Output.....	5-3
5.10. How to Enable Beep Function	5-4
5.11. How to Set Priority for Pilot and Co-Pilot.....	5-4
5.12. How to Enable or Disable Voice Warning.....	5-4
5.13. User Button.....	5-5
5.14. iFamily® and Other Connecting Devices.....	5-5
6. OPERATION MANUAL	
6.1. Left Menu Description.....	6-1
6.2. Right Menu Description.....	6-2
6.3. How to Change Configuration.....	6-3
6.4. Volume Level into Headphones.....	6-3
6.5. Transmit Aircraft Identification.....	6-3
6.6. Playing Communication with TWR.....	6-4
6.7. Playing Checklist.....	6-4
6.8. Isolate Function.....	6-4
6.9. Permanent Communication Between Pilots.....	6-4
6.10 Mute AUX Music Input.....	6-5
6.11 Disabling Warning Message.....	6-5
6.12 Emergency Message Activation.....	6-5
6.13 Transmitting Priority.....	6-6
6.14 Creating or Editing Checklist Name.....	6-6
6.15 Recording Checklist.....	6-6
6.16 Setting Squelch Level.....	6-6

1. GENERAL DESCRIPTION

1.1. INTRODUCTION

The TL-2424 is complete management of voice in your aircraft.

1.2. INSTRUMENT DESCRIPTION

The TL-2424 enables the communication between the pilot and co-pilot while using intelligently managed voice activator (VOX).

The TL-2424 enables playing voice warnings from the particular instruments directly to the headphones (e.g. from the Thermometer - Warning! The exhaust temperature number one is over)

The TL-2424 enables recording the communication from the RDST for re-playing the messages in case you were not able to understand or remember some information from the tower, e.g. about the runway used, or barometric pressure.

The TL-2424 enables transmitting a pre-recorded message, e.g. the aircraft identification.

The TL-2424 enables playing the user-recorded checklist before or after the flight etc. directly to the headphones. It also offers simple orientation just by selecting in the scroll menu on the Intercom's display.

The TL-2424 enables the repeated transmission of the emergency message simply by pressing the button.

The TL-2424 is provided with the function ISOLATE, the adjustable SIDE TONE, the AUX inputs for playing music to the headphones or for recording all communication in an external recording unit.

The User button can be programmed in the main set-up for a quick function.

It is possible to download new Warning Messages or a Check List via the serial cable RS-232c from your PC.

1.3. TECHNICAL SPECIFICATIONS

The producer guarantees all stated technical parameters only when the instrument is installed by an authorized service or an aircraft manufacturer.

1.3.1 Physical Characteristics

Width	71mm (2.795 inches)
Height	67mm (2.637 inches)
Depth	92mm (3.622 inches) including connectors with cover
Panel hole	57mm (2.244 inches) diameter
TL-2424 Weight	0.25 kg (0.55 lbs)
TL-2424 Harness	0.05 kg (0.11 lbs)

1.3.2 General Specifications

Operating Temperature Range	-20°C to +70°C
Humidity	95% non-condensing
Altitude Range	4600 meters max.
Power Range	10.0 to 32.0 Volts
Max. Transceiver KEY output	30 Volts, 1 Ampere
Power Consumption	0.15 Ampere @ 14 VDC
Backlight Consumption	0.08 Ampere max when ext. power is used
Vibration	5 to 500 Hz
Show Rate (LCD Refresh)	1 second

1.3.3 Long-term Memory and Communication

Memory Capacity	32MB
Stored Values	voice and configuration data
Data Saved Endurance	10 years
Voice Memory Life-time	1 million TWR communication storing
Communication	RS-232c
Communication Speed	38400 bps

1.3.4 Audio Parameters

Samples rate of recorded voice	8000Hz / Mono / 8 bit with Codec
Microphone input line	370mV@114dB
Phone output line	100 mW@500ohms
AUX input line	0.2 to 2 Volts (typ. 0.5 V)@1kHz
AUX output line	50 mV (typ. 25 mV)@1kHz

1.4. LIMITED CONDITIONS

1.5. LIMITED WARRANTY

The TL elektronik company warrants this product to be free from defects in materials and manufacture for three years from the date of purchase. TL elektronik will, at its sole option, repair or replace any components that fail in normal use. Such repairs or replacement will be made at no charge to the customer for parts or labour. The customer is, however, responsible for any transportation costs. This warranty does not cover failures due to abuse, misuse, accident or unauthorized alteration or repairs.

THE WARRANTIES AND REMEDIES CONTAINED HEREIN ARE EXCLUSIVE AND IN LIEU OF ALL OTHER WARRANTIES EXPRESS OR IMPLIED OR STATUTORY, INCLUDING ANY LIABILITY ARISING UNDER ANY WARRANTY OF ENCHANT ABILITY OR FITNESS FOR A PARTICULAR PURPOSE, STATUTORY OR OTHERWISE. THIS WARRANTY GIVES YOU SPECIFIC LEGAL RIGHTS, WHICH MAY VARY FROM STATE TO STATE.

IN NO EVENT SHALL TL ELEKTRONIC BE LIABLE FOR ANY INCIDENTAL, SPECIAL, INDIRECT OR CONSEQUENTIAL DAMAGES, WHETHER RESULTING FROM THE USE, MISUSE, OR INABILITY TO USE THIS PRODUCT OR FROM DEFECTS IN THE PRODUCT. SOME STATES DO NOT ALLOW THE EXCLUSION OF INCIDENTAL OR CONSEQUENTIAL DAMAGES, SO THE ABOVE LIMITATIONS MAY NOT APPLY TO YOU.

To obtain warranty service, call the TL elektronik Customer Service (+420 49 548 23 92) for a returned merchandise tracking number. The unit should be securely packaged with the tracking number clearly marked on the outside of the package and sent freight prepaid and insured to a TL elektronik warranty service station. A copy of the original sales receipt is required as the proof of purchase for warranty repairs. TL elektronik retains the exclusive right to repair or replace the unit or software or offer a full refund of the purchase price at its sole discretion.

SUCH REMEDY SHALL BE YOUR SOLE AND EXCLUSIVE REMEDY FOR ANY BREACH OF WARRANTY.

1.6. LIMITED OPERATION

**This product is not TSO approved as a flight instrument, therefore, the manufacturer will not be held responsible for any damage caused by its use.
The TL elektronik company is not responsible for any possible damage caused by faulty functioning such as disabling communication with a control tower caused by faulty functioning or incorrect setting of the instrument.**

2. INSTALLATION

2.1 INTRODUCTION

Careful planning and consideration of the suggestions in this section are required to achieve the desired performance and reliability from the TL-2424.

2.2 RACK CONSIDERATION

Plan a location that gives the pilot complete and comfortable access to the entire keypad and that is plainly visible from the pilot's perspective. Check that there is adequate depth for the rack in the instrument panel. A place away from heating vents or other sources of heat generation is optimal.

2.3 INSTALLATION INTO PANEL

⚠ Connect the cables into the connector and use the connector cover. Secure the incoming leads to prevent their effect on the connector in the vertical direction.

⚠ If possible, always use shaded wires for connecting to the Intercom so that you prevent possible interference from other equipment, which could result in cracking noises in the headphones.

Mounting Rack Dimension

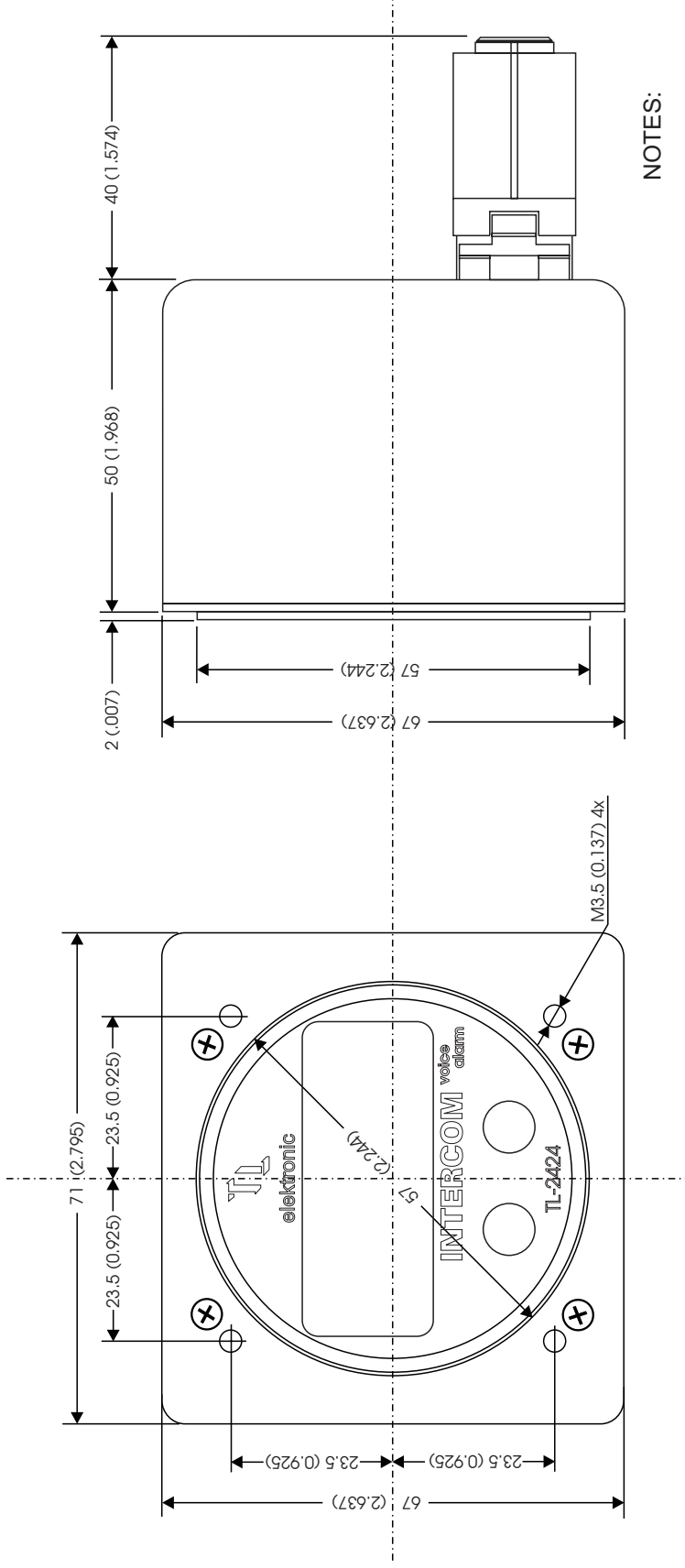

NOTES:

1. Dimension: mm (INCH)
2. Unit weight: 0.25 kg (0.55 lbs)
3. Mounting Rack & Hardware weight: 0.05 kg (0.11 lbs)

Figure 1. Rack Dimension

3.1 PIN FUNCTION LIST

Pin	Pin Name	I/O
1	Microphone input for Pilot's headphones	In
2	Phone output for Pilot's headphones	Out
3	AUX input for Music or Voice	In
4	AUX output for recorder or other unit	Out
5	Microphone input for Co-Pilot's headphones	In
6	Phone output for Co-Pilot's headphones	Out
7	Aircraft power	In
8	Aircraft ground	- -
9	Input for Pilot PTT button	In
10	Input for ISOLATE button	In
11	Input for backlight	In
12	Internal source for backlight	Out
13	Input for Co-Pilot's PTT button	In
14	Ground for Audio line	- -
15	Input for User button	In
16	Ground for User button input	- -
17	Audio output to transceiver	Out
18	Audio input from transceiver	In
19	iFamily® communication ISCL	I/O
20	iFamily® communication ISDA	I/O
21	Transmit Key output to transceiver	Out
22	Ground for PC communication (RS-232)	- -
23	RXD from PC (RS-232)	In
24	TXD to PC (RS-232)	Out

Accessories Interconnect

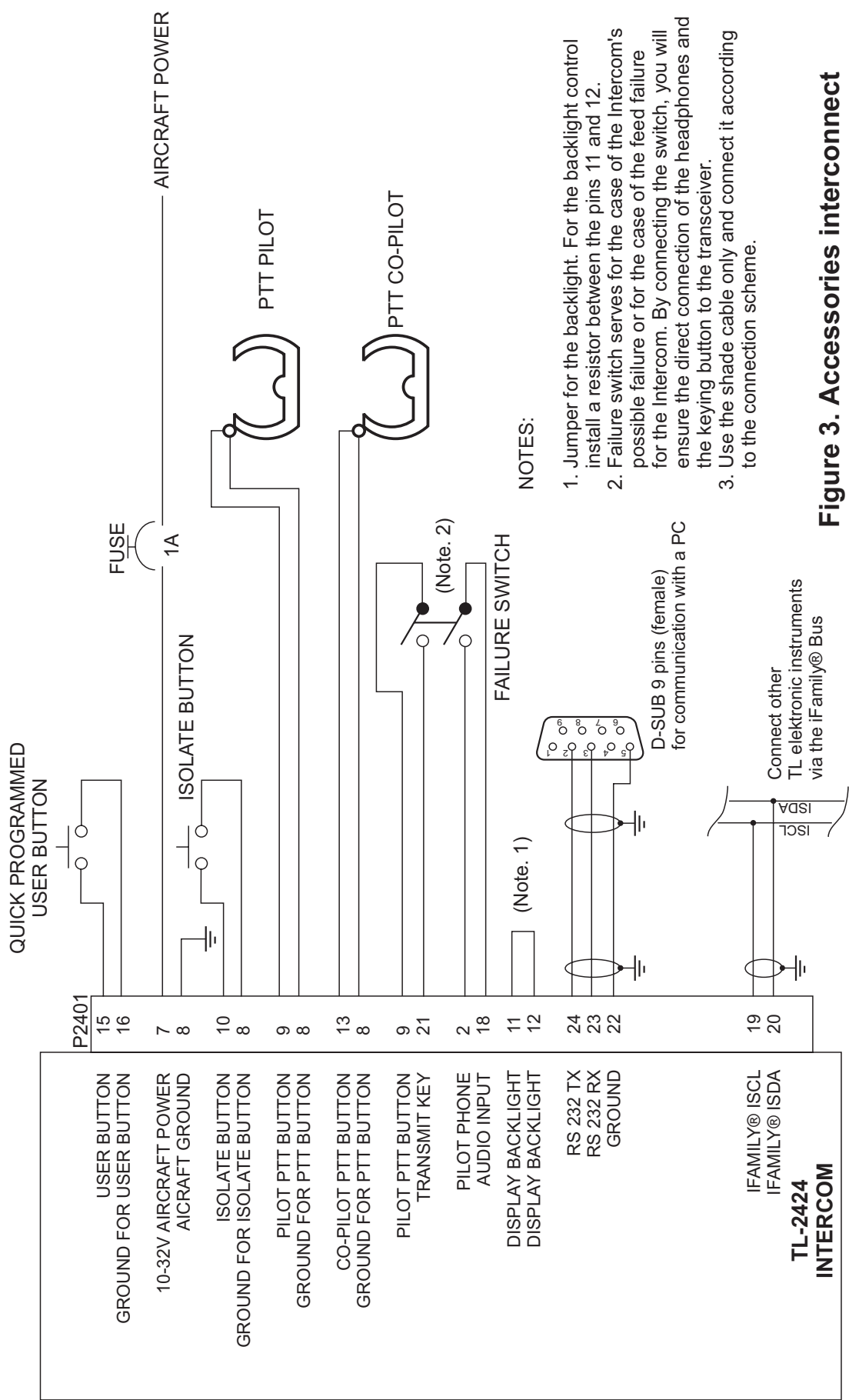

Figure 3. Accessories interconnect

Accessories Interconnect - Audio

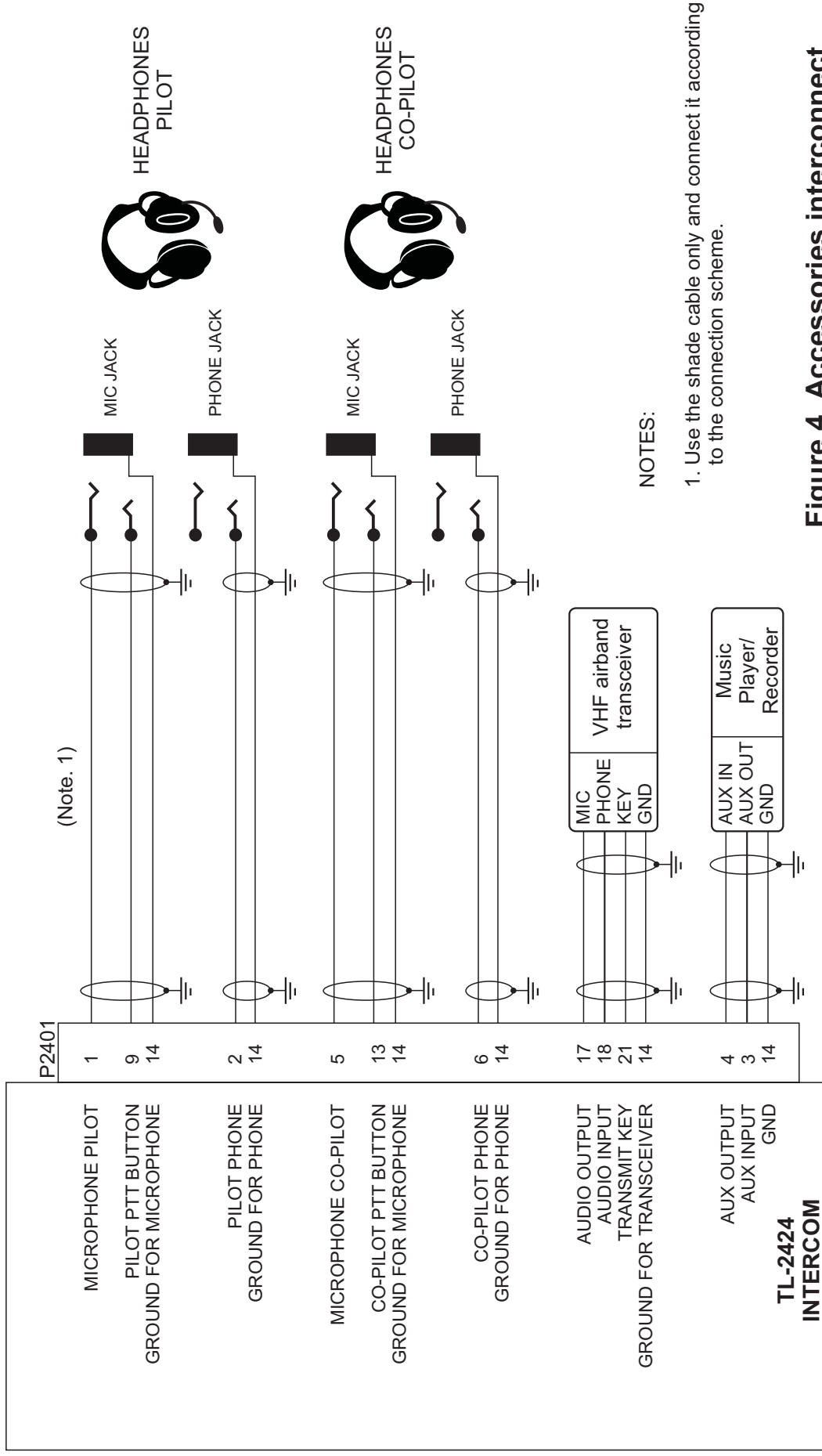
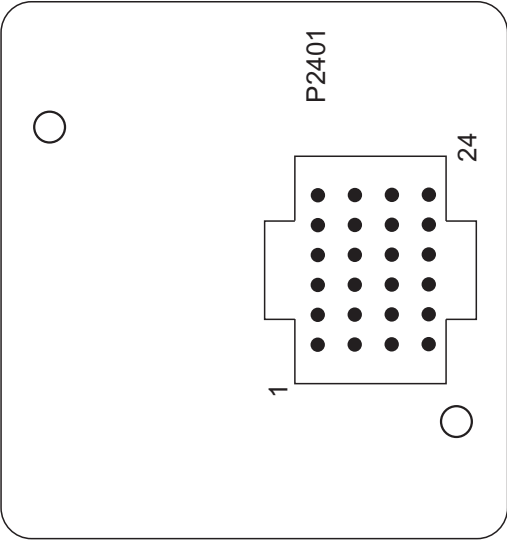

Figure 4. Accessories interconnect

Rear view of connector plate



NOTES:

- 1. Secure the incoming leads to prevent their effect on the connector in the vertical direction.

Figure 5. Connectors locate

4. NAV-MENU DESCRIPTION

4.1 How to Control Instrument via NAV-MENU

There are black labels on the display. Each is affiliated to the left and the right button. Before pressing a button, read the information on the label. Its functions are different in every menu.

The left label is for the Left button.

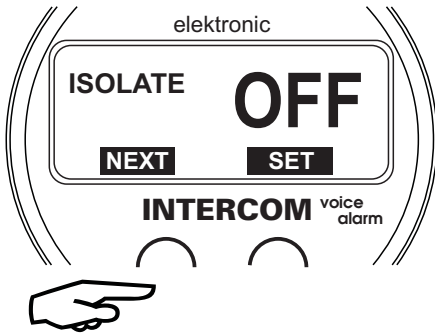

The right label is for the Right button.

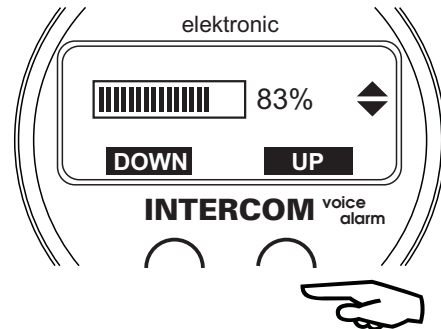

To store a value into the memory, press both buttons simultaneously. Release the buttons when the setting arrows vanish.



5. INSTRUMENT SETUP

5.1 First Instrument Turn-on

Before the Intercom starts to indicate, you must do the basic setting of language, contrast, etc. After the first turn-on of the instrument, the „FIRST SETUP“ message will show on the display. This set-up must be completed to continue.

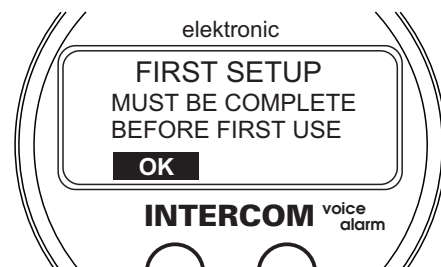

5.2 Main Setup Functions' Description

The table of the instrument configuration steps is shown below (Initial - firmware version 1.0).

0	LANGUAGE	Select your language for communication with the instrument.
1	DISPLAY CONTRAST	Select the contrast of the display.
2	PASSWORD	Select your password.
3	SIDE TONE VOLUME	Set the SIDE TONE volume to your headphones.
4	WARNING MSG VOLUME	Set the WARNING MSG volume to your headphones.
5	TRANSMIT ID	Select whether you want to transmit the aircraft's identification automatically after pressing the button.
6	RECORD ID (only when the function Transmit ID is enabled)	Record the message that will be transmitted to a TWR after pressing the button.
7	EMERGENCY WARNING	Select whether you want the function of Emergency message.
8	RECORD EMERGENCY (only when the function Emergency MSG is enabled)	Record the message that will be transmit in the emergency frequency in 1-minute intervals.
9	AUX OUTPUT	Select which audio signal will be transmitted into the output AUX: PILOT = signal from pilot's mic, CO-PILOT = signal from co-pilot's mic, WARNING = voice Warning messages, COMM = communication via the transceiver (reception, transmission).
10	BEEP FUNCTION	Function of acoustic signal while starting comm. between pilot and co-pilot. ENABLE = beep, DISABLE = no beep, INT = signal to headphones only (TWR will not hear the signal).
11	PTT PRIORITY	Select transmitting priority. PILOT = the pilot will have priority for transmitting, CO-PILOT = the co-pilot will have the priority for transmitting (useful for instructors - the instructor interrupts the student's communication and transmits the message from his/her headphones)
12	USER BUTTON	Program your button for these functions: PLAY LAST COMM = plays the latest message you have heard in the transceiver (by pressing the button repeatedly it is possible to play other previous messages), TRANSMIT ID = plays and transmits the message recorded in the SETUP.
13	VOICE WARNING	Enable or disable voice warning into your headphones
14	INST. ON-LINE	Check the connected instruments from the TL elektronik iFamily® that are On-Line.



All information on this page is subject to change without prior notice. Download the latest version of the manual from www.tl-elektronic.com and compare it with your version of the firmware.

5.3 How to Set Side Tone Volume

In case of transmitting via a transceiver, set the volume level of hearing in your headphones. In the transmission mode the Intercom only monitors the communication between the headphones and the transceiver, and as particular transceivers differ from each other, it is necessary to set the appropriate volume level. After each change of the volume level by pressing the buttons "UP" or "DOWN" a five-second test is performed.

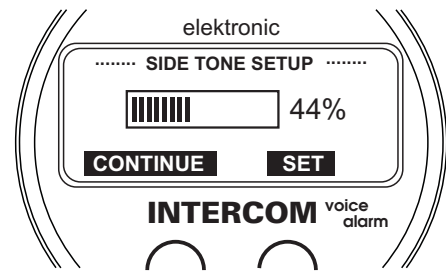

⚠ Remember that during testing, the real transmission is taking place, therefore keep the radio terminology and do not transmit in an often-used frequency.

⚠ The volume level of hearing from the transceiver should be identical with the volume level during the communication between the pilots.

5.4 How to Set Warning Message Volume

Set the volume level of the Warning messages you will hear in your headphones in case that you have some other instruments connected via the iFamily Bus and if a set limit has been exceeded in any of them. This set-up also serves as the set-up of the checklist volume level. After each change of the volume level by pressing the buttons "UP" or "DOWN" a Warning message is played.

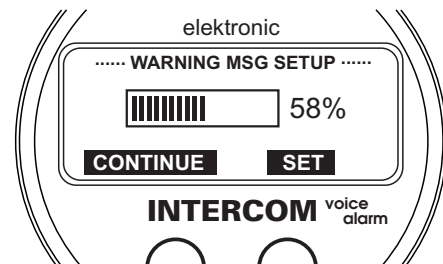

⚠ The volume level of the Warning messages should be identical with the volume level during the communication between pilots.

5.5 How to Enable Identification Playing Mode

The Intercom offers you the function of playing the aircraft's identification or another rather long message that is played frequently. The message is always played after the activation in the main menu. You can record the message according to the point 5.6.

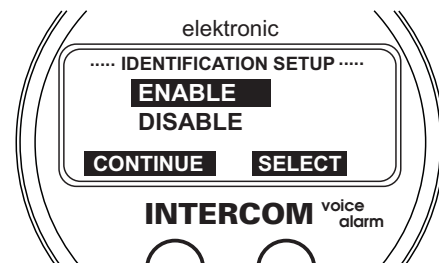

5.6 How to Record Identification

In the "IDENTIFICATION RECORD" you can record the aircraft's identification or other messages. Once you are ready, press the button "START" to start recording. Having finished, press the button "STOP".

If you have recorded the message and do not want to repeat recording, press the button "EXIT". In the opposite case, press the button "START" to repeat recording.



5.7 How to Enable Emergency Mode

If you enable the function of the Emergency message, this message will be transmitted via the transceiver in 1-minute intervals. Transmitting the Emergency message can be activated in the second menu. You can record the message according to the point 5.8.

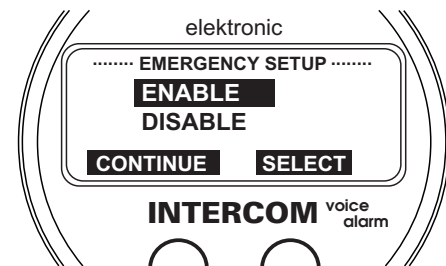

5.8 How to Record Emergency Message

In the "EMERGENCY RECORD" you can record the Emergency message or other messages. Once you are ready, press the button "START" to start recording. Having finished, press the button "STOP".

If you have recorded the message and do not want to repeat recording, press the button "EXIT". In the opposite case, press the button "START" to repeat recording.



5.9 How to Select Audio Source to AUX Output

Select which audio signal will be transmitted to the AUX output. You can select one of the options described in details in the point 5.2. If you select e.g. the item COMM, then after connecting a recorder you can record the entire communication via the transceiver, i.e. both the reception and the transmission.

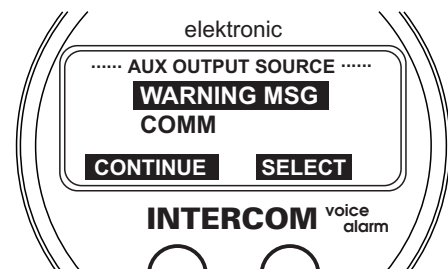

5.10 How to Enable Beep Function

If you enable the Beep function, you will be given a notice before starting transmission. Once you press the button for transmitting, first a short beep will sound and only after that the transmission will be started. This function is useful especially when an accidental press of the button may occur. In this way, you prevent undesirable transmission.

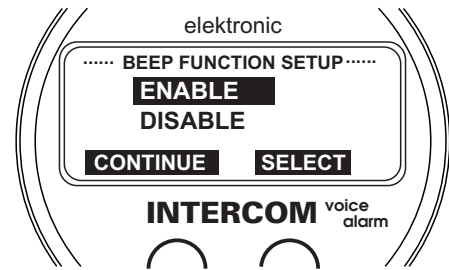

⚠ This Beep function also offers the TWR option, which ensures transmitting the beep sound in the moment of pressing the PTT button, e.g. as the confirmation for a TWR or another aircraft.

⚠ In some countries, using the TWR function for transmitting the tone may be out of accord with the telecommunication operation. Before activating this function consult its legal consequences with the local telecommunication authority.

5.11 How to Set Priority for Pilot and Co-Pilot

The Intercom offers you the possibility to select which pilot will be given the transmitting priority. For example, if an instructor is the co-pilot and is given the priority, he/she can at any time interrupt the student's transmission and transmit from his/her headphones via the transceiver. In case that the aircraft is operated in an air school, select the Co-pilot. In the opposite case select the Pilot.

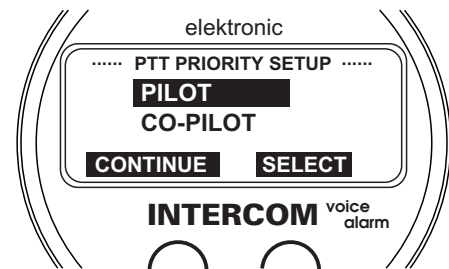

5.12 How to Enable or Disable Voice Warning

In this menu you can turn on/off playing the Warning messages permanently. If you do not want the Intercom to play the Warning messages from the instruments in case of exceeding the set limits, select "DISABLE".

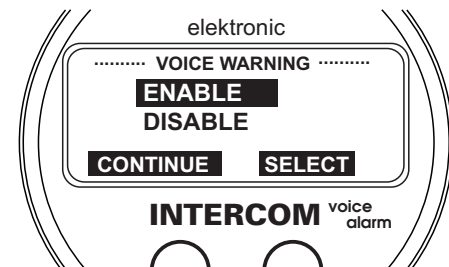

5.13 User Button

When pressed, the external User button offers you the possibility of programming to quick action or quick switch to the selected menu. For example - if you have set PLAY LAST COMM, after pressing the button the Intercom will go directly to the menu of playing the latest communication from the transceiver.

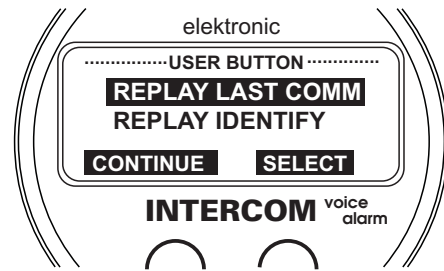

5.14 iFamily® and Other Connecting Devices

As the first of aircraft instruments, the TL-2424 enables you the connection with other instruments of the TL elektronik family in order to receive Warning messages from the particular instruments and to play them in your headphones, or the mass PC download from all connected instruments etc. via one cable. If some other instruments or the GPS are connected to the reserved inputs, this menu shows each connected instrument. It also enables checking the connected instruments and devices.

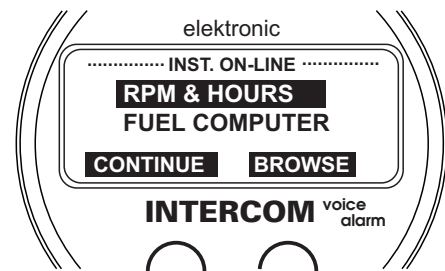

6. OPERATIONAL MANUAL

6.1. Left Menu Description

The left main menu shows the functions according to the table below.

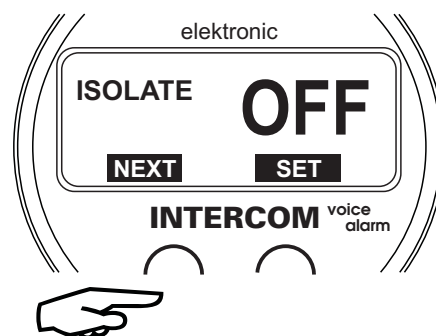

Left Menu (Initial firmware version 1.0)

First	Second	Description
VOLUME		Volume level in your headphones.
TRANSMIT ID		Transmitting pre-recorded aircraft identification.
PLAY LAST COMM		Playing last reception from transceiver.
CHECKLIST		Playing checklist.
ISOLATE		Isolate function.
PERMANENT COMM		Permanent communication between pilots
AUX MUTE		Mute function for AUX input.
WARNING MUTE		Mute function for Warning message.
	EMERGENCY	Transmitting Emergency message.
	PRIORITY	Transmitting priority Setup.
	AUX VOLUME	Volume level for AUX music input.
	EDIT CHECKLIST	Edit and Record Checklists.

 All information on this page is subject to change without prior notice. Download the latest version of the manual from www.tl-elektronic.com and compare it with your version of firmware.

6.1.1 Second Menu

The „OTHER“ dialog will show on the display after pressing the left button. If you press „YES“ in this dialog, the instrument will go to the second menu where you can find other functions.

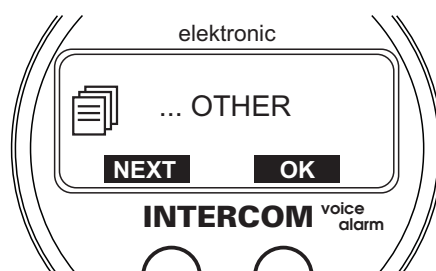

6.2 Right Menu Description

The right menu shows the functions according to the table below.

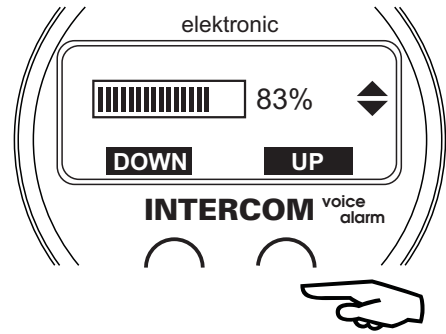

Right Menu (Initial firmware version 1.0)

First	Second	Description
ACTIVATE		Setting squelch level.

⚠ All information on this page is subject to change without prior notice. Download the latest version of the manual from www.tl-elektronik.com and compare it with your version of firmware.

6.2.1 Exit from Right Menu

Exit from the right menu is done automatically after a few seconds if there is no button being pressed.

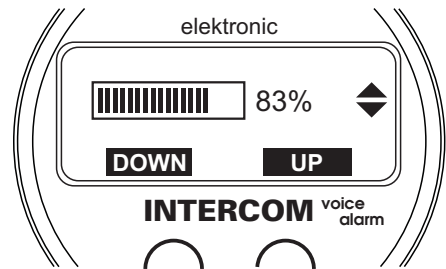

6.3 How to Change Configuration

If you want to change e.g. configuration or contrast, press and hold both buttons and turn the instrument on. The „Setup“ message will show on the display. Press „OK“ and go to the instrument set-up.

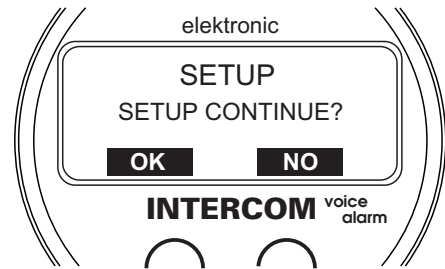

⚠ Note, that any unauthorized change of values in the set-up can cause defect of the instrument. An incorrect change of the configuration could endanger your life and the lives of your passengers.

6.4 Volume Level into Headphones

In this menu you can set the volume level for the headphones. If your headphones incorporate volume control, set the volume level in this menu to 100%, and then adjust it to the desired level by the volume control in the headphones.

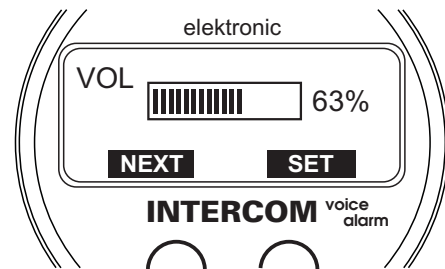

6.5 Transmit Aircraft Identification

Via the transceiver, you can play and transmit the aircraft identification or some other information stored in the Setup menu. To start playing, press the confirmation button "OK".

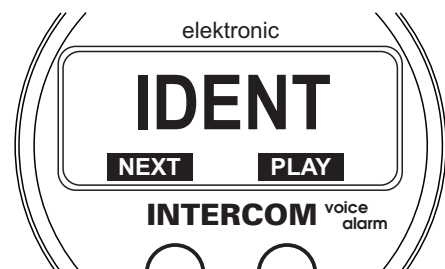

6.6 Playing Communication with TWR

Play the previous communication from the transceiver to your headphones. To play the latest communication, press the button "PLAY" in the "TWR" menu. If you want to play the previous messages, during playing press the button "REW" twice. If you press the button "REW" only once during playing, the current message starts playing from the beginning. To stop playing, press the button "EXIT".

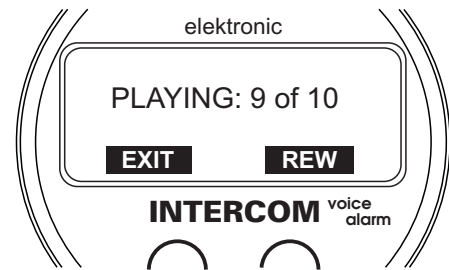

6.7 Playing Checklist

You can play the checklist easily by selecting in the menu. The checklist starts playing 2 seconds after releasing the button over the particular checklist. You can create a checklist in the second menu according to the point 6.14.

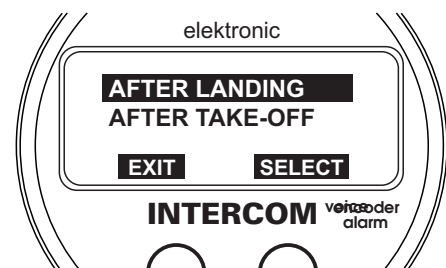

6.8 Isolate Function

The Intercom offers you the function "ISOLATE", which is used for disconnecting the co-pilot's microphone. With this function on, you are disturbed neither by the co-pilot nor by the sound from the AUX input; there will be only reception from the transceiver and warning information from instruments in the pilot's headphones.

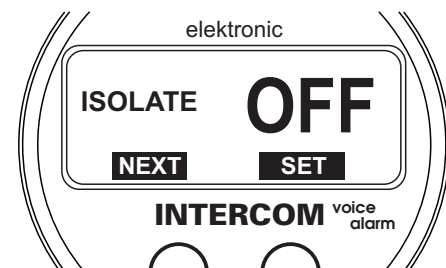

6.9 Permanent Communication Between Pilots

In this menu you can turn on/off the permanent communication between the pilot and the co-pilot. Turning the permanent communication on is only temporary till the moment of turning the Intercom off.

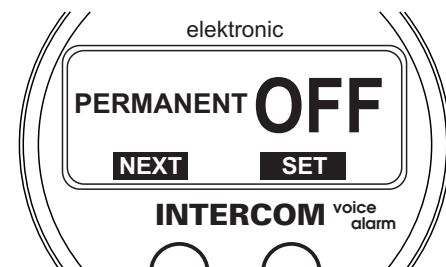

6.10 Mute AUX Music Input

The sound from the AUX input can be turned on/off in this menu. Another option is selecting the function "AUTO". The AUX music input is always muted if the pilots start communicating, or if reception from the transceiver is started, or if a Warning message sounds.

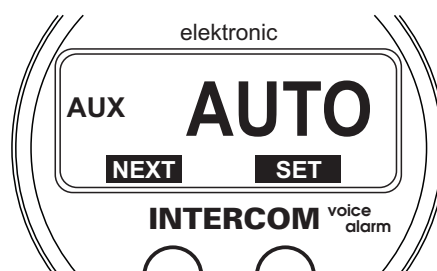

6.11 Disabling Warning Message

In this menu you can temporarily turn off playing warning messages to your headphones. This setting is only temporary till the moment of turning the Intercom off. The permanent turn-off of warning messages can be carried out in the Setup menu according to the point 5.12.

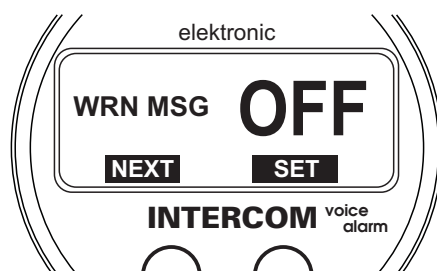

6.12 Emergency Message Activation

You can activate an Emergency message with the voice message you have recorded in the Setup Menu. If this function is not enabled in the Setup menu, this menu does not display in the selection of the second menu.



⚠ The Emergency message is used in case you need to transmit a message in 30-seconds intervals. Remember that while activating this function it is necessary to set an emergency frequency in your transceiver.

6.13 Transmitting Priority

The Intercom enables you to give the transmitting priority to one of the pilots. For example, if an instructor is the co-pilot and is given the priority, he/she can at any time interrupt the student's transmission and transmit from his/her headphones via the transceiver. This setting is only temporary till the moment of turning the Intercom off. The permanent transmitting priority can be set in the Setup menu according to the point 5.11.

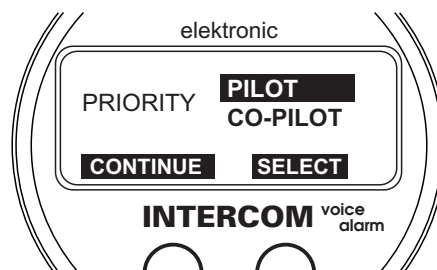

6.14 Creating or Editing Checklist Name

Create a new checklist including the name and voice information, or modify the present checklist. If you have not created any checklist yet, there is only the field "MAKE NEW ITEM" on the list for creating a new checklist. Press the confirmation button "DONE". Then enter the name of the checklist and press the button "TAB" so many times that the cursor is positioned at the end of the line. Then press the button "OK". If it concerns only the voice modification of an already-functioning checklist, just press the button "OK" to go to recording the checklist.

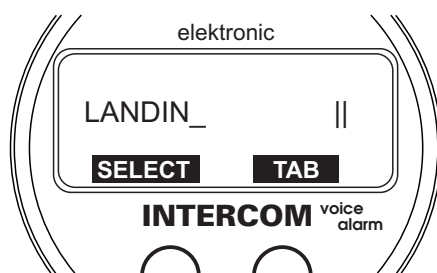

6.15 Recording Checklist

In this menu you can record a message for the particular checklist. Once you are ready, press the button "START" to start recording the checklist. Having finished, press the button "STOP". If you have recorded the message and do not want to repeat recording, press the button "EXIT". In the opposite case, press the button "START" to repeat recording.



6.16 Setting Squelch Level

Set the level of activating the communication between the pilot and co-pilot. Remember that while e.g. increasing the rotation speed of the engine, the level of noise may activate the Intercom, and therefore it will be necessary to modify the activation level several times until the Intercom works in the correct way.

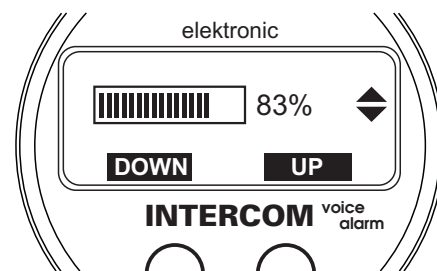

This page intentionally left blank